

FEATURES

- Ultra Low Dropout Voltage
- Low Ground Pin Current
- Excellent Line and Load Regulation
- Available in SOT-223 Package
- Fixed Output Voltages : 1.0V, 1.1V, 1.2V, 1.5V, 1.8V, 2.5V, and 3.3V
- Over-Temperature/Over-Current Protection
- -40°C to 125°C Junction Temperature Range
- Moisture Sensitivity Level 3

APPLICATION

- Battery Powered Equipments
- Motherboards and Graphic Cards
- Microprocessor Power Supplies
- Peripheral Cards
- High Efficiency Linear Regulators
- Battery Chargers



SOT-223 3L PKG

ORDERING INFORMATION

Device	Package
TJ1119S-X.X	SOT-223 3L

X.X = Output Voltage = 1.0, 1.1, 1.2, 1.5, 1.8, 2.5, and 3.3

DESCRIPTION

The TJ1119 series of high performance ultra low-dropout linear regulators operates from 2.5V to 5.5V input supply and provides ultra low-dropout voltage, high output current with low ground current. Wide range of preset output voltage options are available. These ultra low dropout linear regulators respond fast to step changes in load which makes them suitable for low voltage micro-processor applications. The TJ1119 is developed on a CMOS process technology which allows low quiescent current operation independent of output load current. This CMOS process also allows the TJ1119 to operate under extremely low dropout conditions.

Absolute Maximum Ratings

CHARACTERISTIC	SYMBOL	MIN.	MAX.	UNIT
Input Supply Voltage (Survival)	V_{IN}	-0.3	6.5	V
Maximum Output Current	I_{MAX}	-	1.0	A
Lead Temperature (Soldering, 5 sec)	T_{SOL}		260	°C
Storage Temperature Range	T_{STG}	-65	150	°C
Operating Junction Temperature Range	T_{JOPR}	-40	125	°C

Operating Ratings

CHARACTERISTIC	SYMBOL	MIN.	MAX.	UNIT
Recommend Operating Input Voltage	V_{IN}	2.5	5.5	V

Ordering Information

V _{OUT}	Package	Order No.	Description	Supplied As	Status
1.0 V	SOT-223 3L	TJ1119S -1.0	0.8A	Reel	Contact us
1.1 V	SOT-223 3L	TJ1119S -1.1	0.8A	Reel	Contact us
1.2 V	SOT-223 3L	TJ1119S -1.2	0.8A	Reel	Contact us
1.5 V	SOT-223 3L	TJ1119S -1.5	0.8A	Reel	Active
1.8 V	SOT-223 3L	TJ1119S -1.8	0.8A	Reel	Contact us
2.5 V	SOT-223 3L	TJ1119S -2.5	1A	Reel	Contact us
3.3 V	SOT-223 3L	TJ1119S -3.3	1A	Reel	Contact us

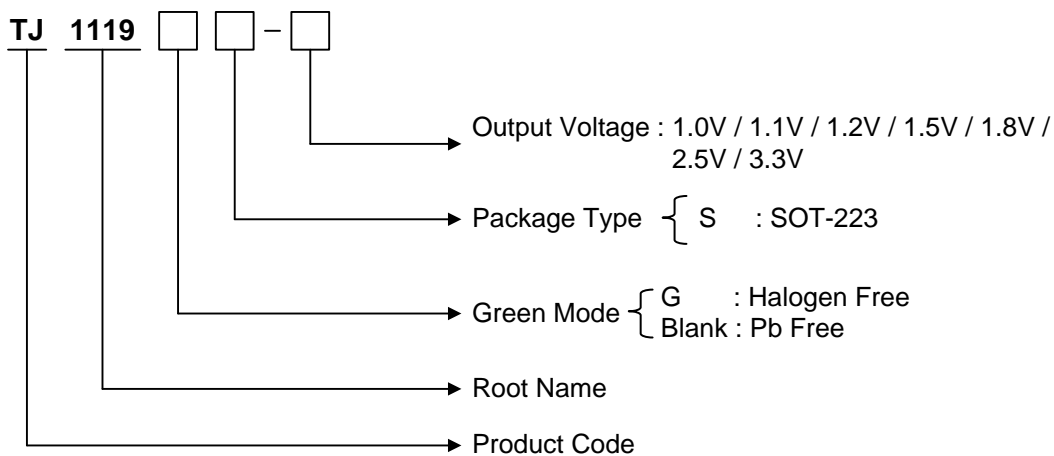

PIN CONFIGURATION

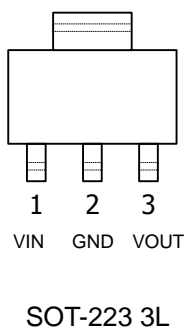

PIN DESCRIPTION

Pin No.	SOT-223 3LD	
	Name	Function
1	VIN	Input Voltage
2	GND	Ground
3	VOUT	Output Voltage

TYPICAL APPLICATION

- Typical Application Circuit

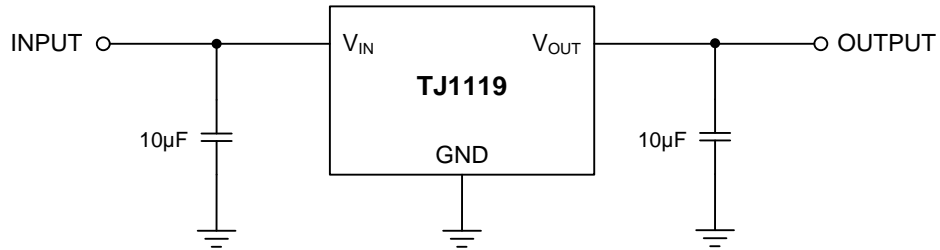

* TJ1119 can deliver a continuous current of 0.8A/1A over the full operating temperature. However, the output current is limited by the restriction of power dissipation which differs from packages. A heat sink may be required depending on the maximum power dissipation and maximum ambient temperature of application. With respect to the applied package, the maximum output current of 0.8A/1A may be still undeliverable.

* See Application Information.

ELECTRICAL CHARACTERISTICS FOR $V_{OUT} \geq 2.5V$ ^(Note 1)

Limits in **standard typeface** are for $T_J=25^\circ C$, and limits in **boldface type** apply over the **full operating temperature range**. Unless otherwise specified: V_{IN} ^(Note 2) = $V_{O(NOM)} + 1V$, $I_L = 10\text{ mA}$, $C_{IN} = 10\text{ uF}$, $C_{OUT} = 10\text{ uF}$, $V_{OUT} \geq 2.5V$

PARAMETER	SYMBOL	TEST CONDITION	MIN.	TYP.	MAX.	UNIT
Output Voltage Tolerance	V_O	$10\text{ mA} < I_L < 1A$ $V_{OUT}+1V < V_{IN} < 5.5V$	-2 -3	0	2 3	%
Output Current	I_O	$V_{OUT} \geq 2.5V$	-	-	1	A
Line Regulation ^(Note 3)	ΔV_{LINE}	$V_{OUT}+1V < V_{IN} < 5.5V$	-	0.15	- 0.40	%/V
Load Regulation ^(Note 3, 4)	ΔV_{LOAD}	$10\text{ mA} < I_L < 1A$	-	1.5	-	%
Dropout Voltage ^(Note 5)	V_{DROP}	$I_L = 100\text{mA}$		55	- 80	mV
		$I_L = 500\text{mA}$		200	- 300	mV
		$I_L = 1A$		450	- 650	mV
Ground Pin Current ^(Note 6)	I_{GND1}	$I_L = 100\text{mA}$	-	0.12	0.15 -	mA
		$I_L = 1A$	-	0.12	0.20 -	
Power Supply Rejection Ratio	PSRR	$f = 1\text{ kHz}$	-	55	-	dB
Thermal Shutdown Temperature	T_{SD}		-	165	-	$^\circ C$

Note 1. Stresses listed as the absolute maximum ratings may cause permanent damage to the device. These are for stress ratings. Functional operating of the device at these or any other conditions beyond those indicated in the operational sections of the specifications is not implied. Exposure to absolute maximum rating conditions for extended periods may remain possibly to affect device reliability.

Note 2. The minimum operating value for input voltage is equal to either ($V_{OUT,NOM} + V_{DROP}$) or 2.5V, whichever is greater.

Note 3. Output voltage line regulation is defined as the change in output voltage from the nominal value due to change in the input line voltage. Output voltage load regulation is defined as the change in output voltage from the nominal value due to change in load current.

Note 4. Regulation is measured at constant junction temperature by using a 10ms current pulse. Devices are tested for load regulation in the load range from 10mA to 1A.

Note 5. Dropout voltage is defined as the minimum input to output differential voltage at which the output drops 2% below the nominal value. Dropout voltage specification applies only to output voltages of 2.5V and above. For output voltages below 2.5V, the dropout voltage is nothing but the input to output differential, since the minimum input voltage is 2.5V.

Note 6. Ground current, or quiescent current, is the difference between input and output currents. It's defined by $I_{GND1} = I_{IN} - I_{OUT}$ under the given loading condition. The total current drawn from the supply is the sum of the load current plus the ground pin current.

ELECTRICAL CHARACTERISTICS FOR $V_{OUT} < 2.5V$ ^(Note 1)

Limits in standard typeface are for $T_J=25^\circ C$, and limits in boldface type apply over the full operating temperature range. Unless otherwise specified: V_{IN} ^(Note 2) = $V_{O(NOM)} + 1V$, $I_L = 10\text{ mA}$, $C_{IN} = 10\text{ }\mu F$, $C_{OUT} = 10\text{ }\mu F$, $V_{OUT} < 2.5V$

PARAMETER	SYMBOL	TEST CONDITION	MIN.	TYP.	MAX.	UNIT
Output Voltage Tolerance	V_O	$10\text{ mA} < I_L < 800\text{mA}$ $V_{OUT}+1V < V_{IN} < 5.5V$	-2 -3	0	2 3	%
Output Current	I_O	$V_{OUT} < 2.5V$	-	-	0.8	A
Line Regulation ^(Note 3)	ΔV_{LINE}	$V_{OUT}+1V < V_{IN} < 5.5V$	-	0.15	- 0.40	%/V
Load Regulation ^(Note 3, 7)	ΔV_{LOAD}	$10\text{ mA} < I_L < 800\text{mA}$	-	1.5	-	%
Dropout Voltage ^(Note 5)	V_{DROP}	$I_L = 100\text{mA}$		55	- 80	mV
		$I_L = 500\text{mA}$		200	- 300	mV
		$I_L = 800\text{mA}$		450	- 650	mV
Ground Pin Current ^(Note 6)	I_{GND1}	$I_L = 100\text{mA}$	-	0.12	0.15 -	mA
		$I_L = 800\text{mA}$	-	0.12	0.20 -	
Power Supply Rejection Ratio	PSRR	$f = 1\text{ kHz}$	-	55	-	dB
Thermal Shutdown Temperature	T_{SD}		-	165	-	$^\circ C$

Note 7. Regulation is measured at constant junction temperature by using a 10ms current pulse. Devices are tested for load regulation in the load range from 10mA to 800mA.

TYPICAL OPERATING CHARACTERISTIC

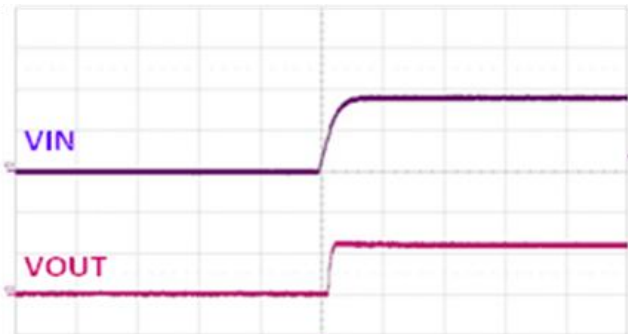

(VIN: 2V/div, VOUT: 2V/div, 1ms/div)
 Vin=3.5V, Vout=2.5V @ Iout=0A

Start Up Transient Response

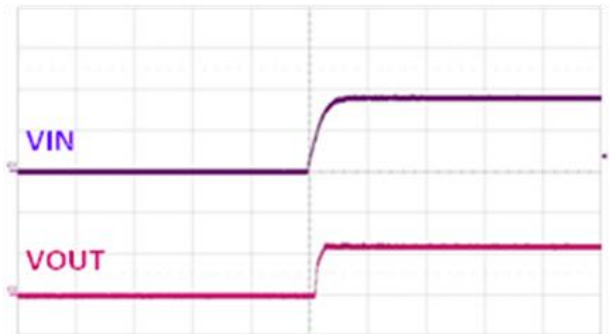

(VIN: 2V/div, VOUT: 2V/div, 1ms/div)
 Vin=3.5V, Vout=2.5V @ Iout=1A

Start Up Transient Response

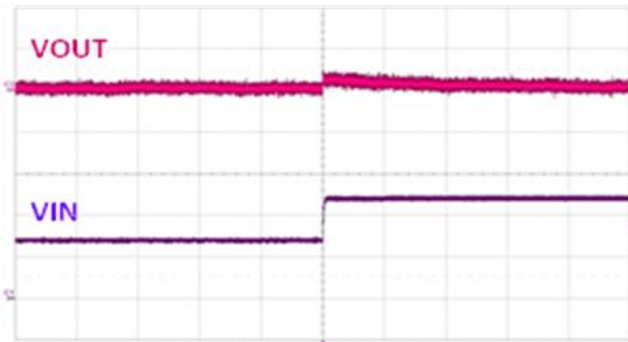

(VIN: 2V/div, VOUT: 20mV/div, 10ms/div)
 Vin=3.5V to 5.5V, Vout=2.5V @ Iout=10mA

Line Transient Response

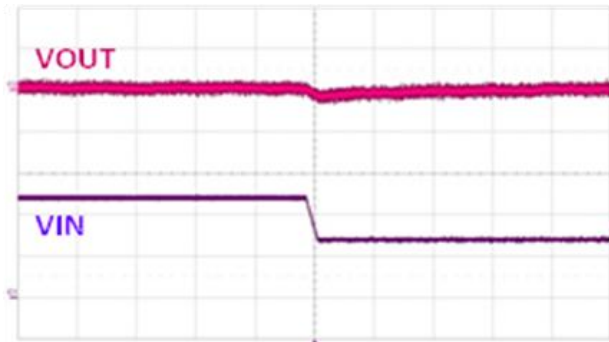

(VIN: 2V/div, VOUT: 20mV/div, 10ms/div)
 Vin=5.5V to 3.5V, Vout=2.5V @ Iout=10mA

Line Transient Response

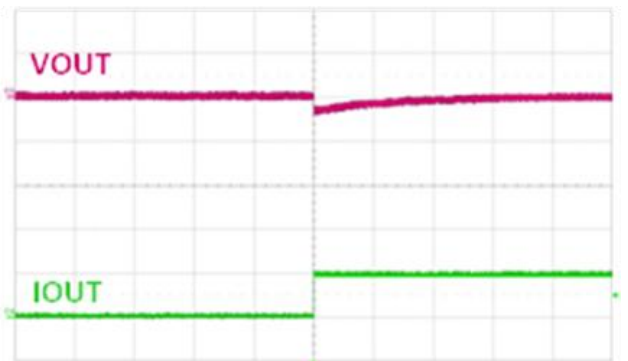

(VOUT: 50mV/div, Iout: 500mA/div, 10ms/div)
 Vin=3.5V, Vout=2.5V @ Iout=10mA to 0.5A

Load Transient Response

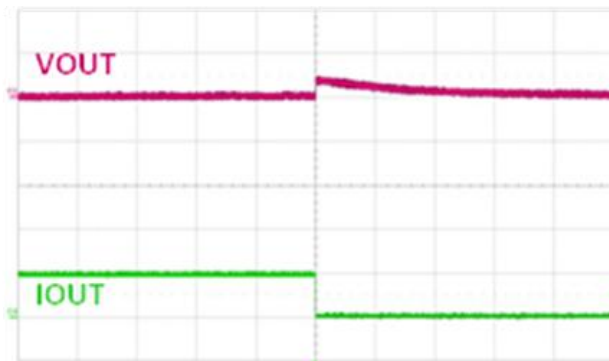

(VOUT: 50mV/div, Iout: 500mA/div, 10ms/div)
 Vin=3.5V, Vout=2.5V @ Iout=0.5A to 10mA

Load Transient Response

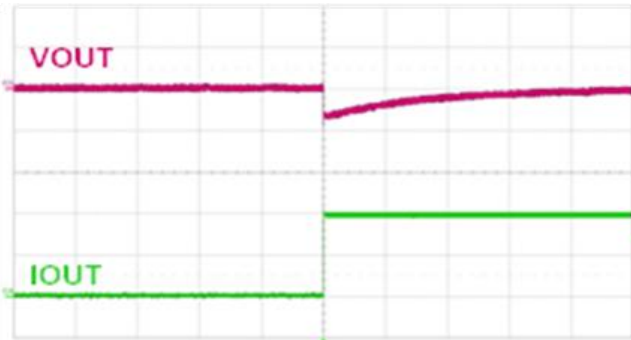

(VOUT: 50mV/div, Iout: 500mA/div, 10ms/div)

Vin=3.5V, Vout=2.5V @ Iout=10mA to 1A

Load Transient Response

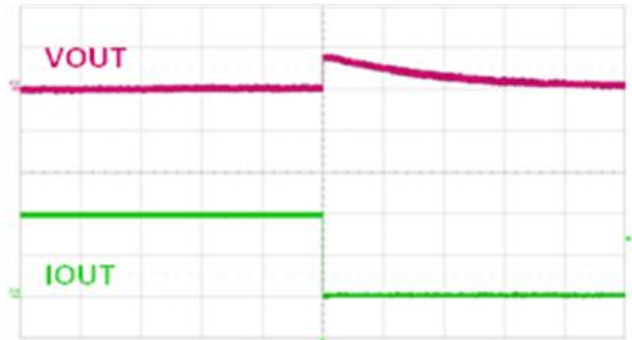

(VOUT: 50mV/div, Iout: 500mA/div, 10ms/div)

Vin=3.5V, Vout=2.5V @ Iout=1A to 10mA

Load Transient Response

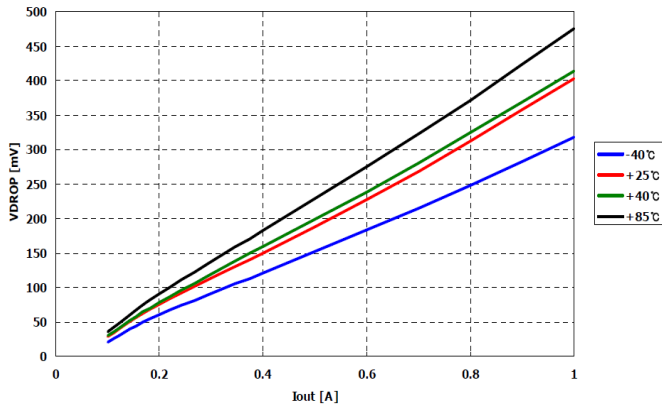

Dropout Voltage vs. Ambient Temperature

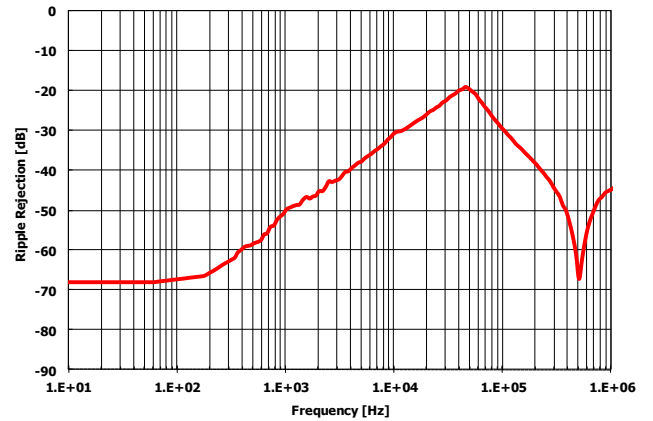

Power Supply Rejection Ratio

APPLICATION INFORMATION

Introduction

TJ1119 is intended for applications where high current capability and very low dropout voltage are required. It provides a simple, low cost solution that occupies very little PCB estate.

Component Selection

Input Capacitor :

A large bulk capacitance over than 4.7uF should be closely placed to the input supply pin of the TJ1119 to ensure that the input supply voltage does not sag. Also a minimum of 4.7uF ceramic capacitor is recommended to be placed directly next to the V_{IN} Pin. It allows for the device being some distance from any bulk capacitor on the rail. Additionally, input droop due to load transients is reduced, improving load transient response.

Output Capacitor :

A minimum ceramic capacitor over than 4.7uF should be very closely placed to the output voltage pin of the TJ1119. Increasing capacitance will improve the overall transient response and stability.

Maximum Output Current Capability

The TJ1119 can deliver a continuous current of 0.8A/1A over the full operating junction temperature range. However, the output current is limited by the restriction of power dissipation which differs from packages. A heat sink may be required depending on the maximum power dissipation and maximum ambient temperature of application. With respect to the applied package, the maximum output current of 0.8A/1A may be still undeliverable due to the restriction of the power dissipation of TJ1119. Under all possible conditions, the junction temperature must be within the range specified under operating conditions.

The temperatures over the device are given by:

$$T_C = T_A + P_D \times \theta_{CA} \quad / \quad T_J = T_C + P_D \times \theta_{JC} \quad / \quad T_J = T_A + P_D \times \theta_{JA}$$

where T_J is the junction temperature, T_C is the case temperature, T_A is the ambient temperature, P_D is the total power dissipation of the device, θ_{CA} is the thermal resistance of case-to-ambient, θ_{JC} is the thermal resistance of junction-to-case, and θ_{JA} is the thermal resistance of junction to ambient.

The total power dissipation of the device is given by:

$$\begin{aligned} P_D &= P_{IN} - P_{OUT} = (V_{IN} \times I_{IN}) - (V_{OUT} \times I_{OUT}) \\ &= (V_{IN} \times (I_{OUT} + I_{GND})) - (V_{OUT} \times I_{OUT}) = (V_{IN} - V_{OUT}) \times I_{OUT} + V_{IN} \times I_{GND} \end{aligned}$$

where I_{GND} is the operating ground current of the device which is specified at the Electrical Characteristics. The maximum allowable temperature rise (T_{Rmax}) depends on the maximum ambient temperature (T_{Amax}) of the application, and the maximum allowable junction temperature (T_{Jmax}):

$$T_{Rmax} = T_{Jmax} - T_{Amax}$$

The maximum allowable value for junction-to-ambient thermal resistance, θ_{JA} , can be calculated using the formula:

$$\theta_{JA} = T_{Rmax} / P_D = (T_{Jmax} - T_{Amax}) / P_D$$

TJ1119 is available in SOT-223. The thermal resistance depends on amount of copper area or heat sink, and on air flow. If the maximum allowable value of θ_{JA} calculated above is as described in Table 1, no heat sink is needed since the package can dissipate enough heat to satisfy these requirements. If the value for allowable θ_{JA} falls near or below these limits, a heat sink or proper area of copper plane is required.

Table. 1. Absolute Maximum Ratings of Thermal Resistance
 No heat sink / No air flow / No adjacent heat source / $T_A = 25^\circ\text{C}$

Characteristic	Symbol	Rating	Unit
Thermal Resistance Junction-To-Ambient / SOT-223	$\theta_{JA-SOT223}$	140	$^\circ\text{C}/\text{W}$

In case that there is no cooling solution and no heat sink / minimum copper plane area for heat sink, the maximum allowable power dissipation of each package is as follow;

Characteristic	Symbol	Rating	Unit
Maximum Allowable Power Dissipation at $T_A=25^\circ\text{C}$ / SOT-223	$P_{DMax-SOT223}$	0.714	W

- Please note that above maximum allowable power dissipation is based on the minimum copper plane area which does not exceed the proper footprint of the package. And the ambient temperature is 25°C .

If proper cooling solution such as heat sink, copper plane area, air flow is applied, the maximum allowable power dissipation could be increased. However, if the ambient temperature is increased, the allowable power dissipation would be decreased.