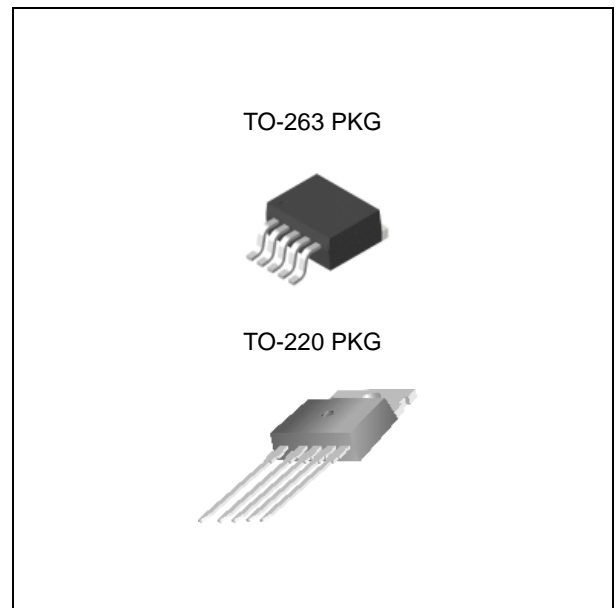

**FEATURES**

- 3.3V, 5V, 12V, and adjustable output versions
- Adjustable version output voltage range, 1.23V to 37V  
± 3% max over line and load conditions
- Guaranteed 5A output load current
- Input voltage range up to 40V
- Requires only 4 external components
- 300kHz ±15% fixed frequency internal oscillator
- Excellent line and load regulation specifications
- Low power standby mode,  $I_Q$  typically 80uA
- Thermal shutdown and current limit protection

**APPLICATION**

- Simple high-efficiency step-down regulator
- On-card switching regulators
- Positive to negative converter

**Ordering Information**

Device	PKG
LM1501BR-X.X	TO-263 5L
LM1501BT-X.X	TO-220 5L

X.X = Output Voltage = 3.3, 5.0, 12, ADJ

**DESCRIPTION**

The LM1501B series of regulators are monolithic integrated circuits that provide all the active functions for a step-down switching regulator, capable of driving a 5A load with excellent line and load regulation. These devices are available in fixed output voltages of 3.3V, 5V, 12V and an adjustable output version. Requiring a minimum number of external components, these regulators are simple to use. The LM1501B series operates at a switching frequency of 300kHz. Available in standard 5-lead TO-263 and TO-220 packages.

Other features include a guaranteed ±3% tolerance on output voltage under specified input voltage and output load conditions, and ± 15% on the oscillator frequency. External shutdown is included, featuring typically 80uA standby current. Self protection features include a current limit for output switch and an over temperature shutdown for complete protection under fault conditions. The over temperature shutdown level is about 145 °C with 5 °C hysteresis.

**Absolute Maximum Ratings** ( $T_A = 25^\circ\text{C}$ ) <sup>(Note 1)</sup>

Characteristic	Symbol	Value	Unit
Maximum Input Supply Voltage	$V_I$	45	V
ON/OFF Pin Input Voltage	$V_{IN}$	$-0.3 \leq V \leq +25$	V
Feedback Pin Voltage	$V_{FB}$	$-0.3 \leq V \leq +25$	V
Output Voltage to Ground	$V_O$	-1	V
Power Dissipation	$P_D$	Internally limited	W
Storage Temperature Range	$T_{stg}$	-65 to +150	°C
Operating Temperature Range	$T_J$	$-40 \leq T_J \leq +125$	°C
ESD Susceptibility (Human Body Model)	$V_{ESD}$	2	kV
Operating Supply Voltage	$V_{IN}$	4.5 to 45	V

Note 1. Absolute Maximum Rating indicate limits beyond which damage to the device may occur. Operating Ratings indicate conditions for which the device is intended to be functional, but do not guarantee specific performance limits. For guaranteed specifications and test conditions, see the Electrical Characteristics.

## Ordering Information

V <sub>OUT</sub>	Package	Order No.	Description	Package Marking	Supplied As
ADJ	TO-263 5L	LM1501BR-ADJ-5L	5A, 300kHz	LM1501B-ADJ	Reel
	TO-220 5L	LM1501BT-ADJ-5L	5A, 300kHz	LM1501B-ADJ	Tube
3.3V	TO-263 5L	LM1501BR-3.3-5L	5A, 300kHz	LM1501B-3.3	Reel
	TO-220 5L	LM1501BT-3.3-5L	5A, 300kHz	LM1501B-3.3	Tube
5.0V	TO-263 5L	LM1501BR-5.0-5L	5A, 300kHz	LM1501B-5.0	Reel
	TO-220 5L	LM1501BT-5.0-5L	5A, 300kHz	LM1501B-5.0	Tube
12V	TO-263 5L	LM1501BR-12-5L	5A, 300kHz	LM1501B-12	Reel
	TO-220 5L	LM1501BT-12-5L	5A, 300kHz	LM1501B-12	Tube

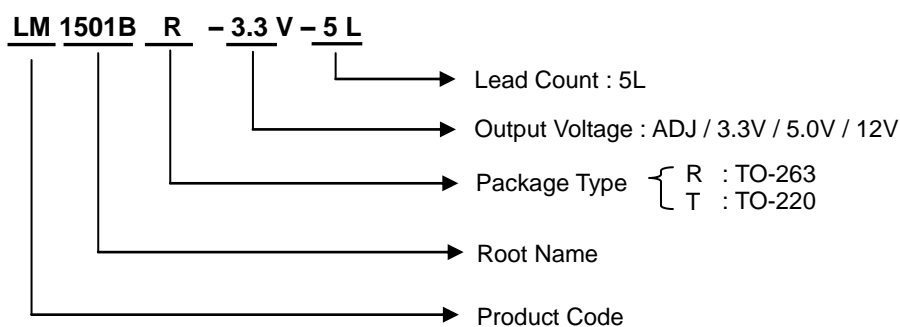

## PIN CONFIGURATION

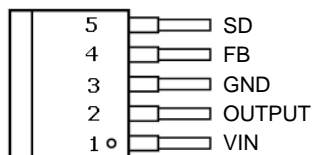

TO-263 5L

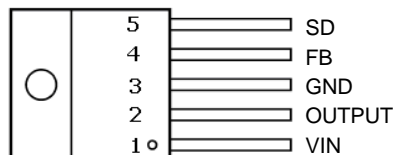

TO-220 5L

## PIN DESCRIPTION

Pin No.	TO-263 / TO-220 5 LEAD	
	Name	Function
1	V <sub>IN</sub>	Operating Input Voltage
2	OUTPUT	Switching Output Voltage
3	GND	Ground
4	FB	Output Voltage Feedback Control
5	SD	ON/OFF Shutdown

## Electrical Characteristics

Unless otherwise specified,  $T_J=25^\circ\text{C}$   $V_{IN}=12\text{V}$  for the 3.3V, 5V, and Adjustable version and  $V_{IN}=24\text{V}$  for the 12V version.  $I_{LOAD}=500\text{mA}$ .

Characteristic	Symbol	Test Condition	Min	Typ	Max	Unit	
Efficiency	$\eta$	LM1501B -ADJ	$V_{OUT}=3\text{V}$ , $I_{LOAD}=5\text{A}$		73		%
		LM1501B-3.3	$V_{IN}=12\text{V}$ , $I_{LOAD}=5\text{A}$		73		
		LM1501B-5	$V_{IN}=12\text{V}$ , $I_{LOAD}=5\text{A}$		80		
		LM1501B-12	$V_{IN}=25\text{V}$ , $I_{LOAD}=5\text{A}$		90		
Output Voltage	$V_{OUT}$	LM1501B-3.3	$4.75\text{V}\leq V_{IN}\leq 40\text{V}$ $0.2\text{A}\leq I_{LOAD}\leq 5\text{A}$	3.20	3.3	3.40	V
		LM1501B-5	$7\text{V}\leq V_{IN}\leq 40\text{V}$ $0.2\text{A}\leq I_{LOAD}\leq 5\text{A}$	4.85	5	5.15	
		LM1501B-12	$15\text{V}\leq V_{IN}\leq 40\text{V}$ $0.2\text{A}\leq I_{LOAD}\leq 5\text{A}$	11.64	12	12.36	
Feedback Voltage	$V_{FB}$	LM1501B-ADJ	$4.5\text{V}\leq V_{IN}\leq 40\text{V}$ $0.2\text{A}\leq I_{LOAD}\leq 5\text{A}$ $V_{OUT}$ programmed for 3V	1.180	1.215	1.250	
Oscillator Frequency	$f_o$		255	300	345	kHz	
Feedback Bias Current	$I_D$	LM1501B-ADJ; $V_{FB}=1.215\text{V}$		15	50	nA	
Saturation Voltage	$V_{SAT}$	$I_{OUT}=5\text{A}$ , (Note 2, 3)			1.4	V	
Max Duty Cycle (ON) Max Duty Cycle (OFF)	DC	(Note 3)		100		%	
		(Note 4)		0			
Current Limit	$I_{CL}$	Peak Current, (Note 2, 3)		6.5		A	
Output Leakage Current	$I_L$	Output = 0V (Note 2, 4)			50	$\mu\text{A}$	
		Output = -1V, $V_{IN}=40\text{V}$		2	30	mA	
Quiescent Current	$I_Q$	(Note 4)		4.5	10	mA	
Standby Quiescent Current	$I_{STBY}$	ON/OFF pin = 5V(OFF), $V_{IN}=40\text{V}$		80	200	$\mu\text{A}$	
ON/OFF Pin Logic Input Threshold voltage	$V_{IH}$ $V_{IL}$	Low (Regulator ON) High (Regulator OFF)			1.3	V	
					0.6		
			2.0				
ON/OFF Pin Logic Input current	$I_H$	$V_{LOGIC}=2.5\text{V}$ (regulator OFF)		5	15	$\mu\text{A}$	
	$I_L$	$V_{LOGIC}=0.5\text{V}$ (regulator ON)			5		

Note 2. No elements connected to output pin

Note 3. Feedback pin removed from output and connected to 0V to force the output transistor switch ON.

Note 4. Feedback pin removed from output and connected to 12V for the 3.3V, 5V, and the ADJ version, and 15V for the 12V version. To force the output transistor switch OFF

## TYPICAL APPLICATION

- Fixed Application Circuit

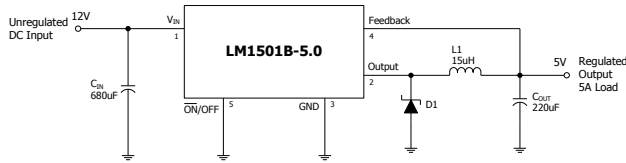

- Adjustable Application Circuit

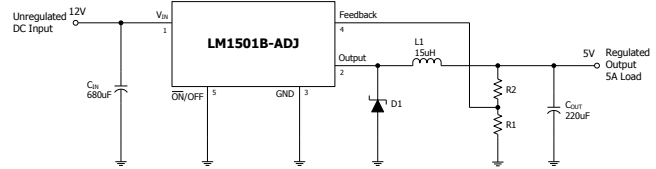

$$V_{OUT} = \left(\frac{R2}{R1} + 1\right) \times V_{FB} = \left(\frac{R2}{R1} + 1\right) \times 1.215V$$

## TYPICAL OPERATING CHARACTERISTICS

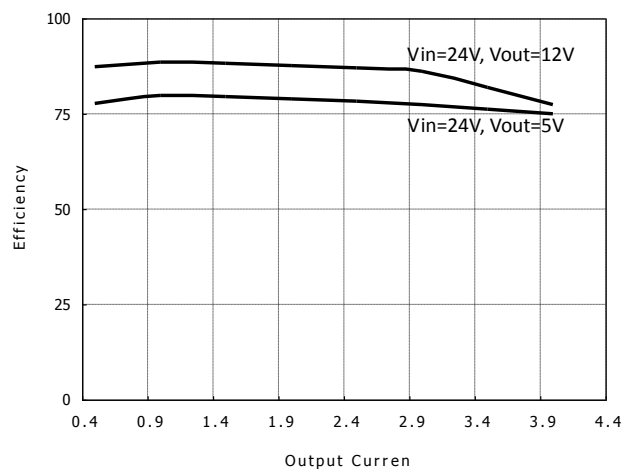
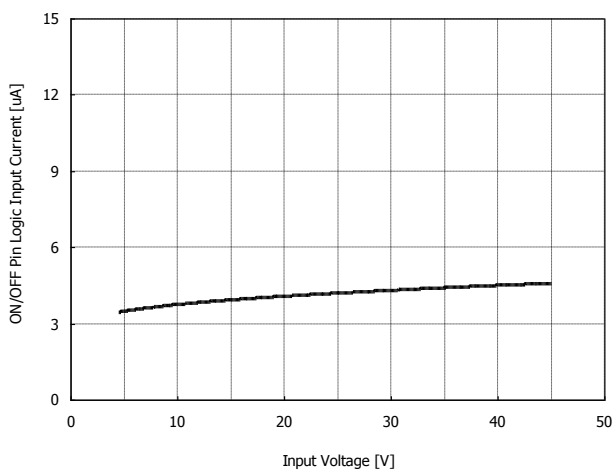
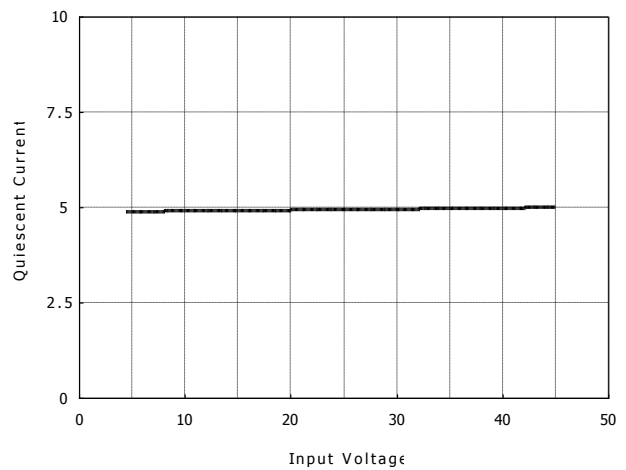
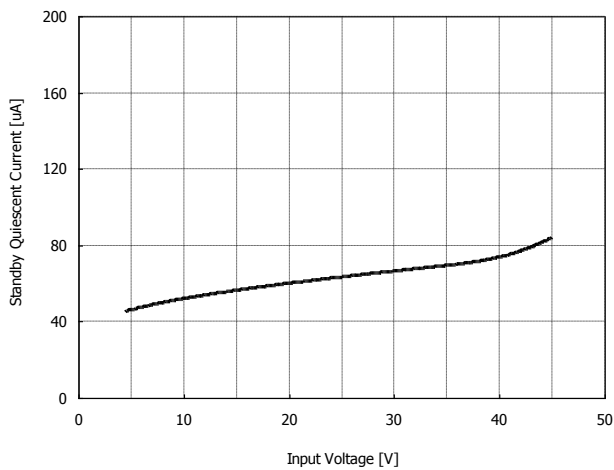

T.B.D

**APPLICATION INFORMATION**

T.B.D